

bürkert
FLUID CONTROL SYSTEMS

Product Overview

Mass Flow Controllers for Gases

01 SOLENOID VALVES

02 PROCESS VALVES

03 PNEUMATICS

04 MEASUREMENT DEVICES

05 MICROFLUIDICS

06

07 PROPORTIONAL VALVES

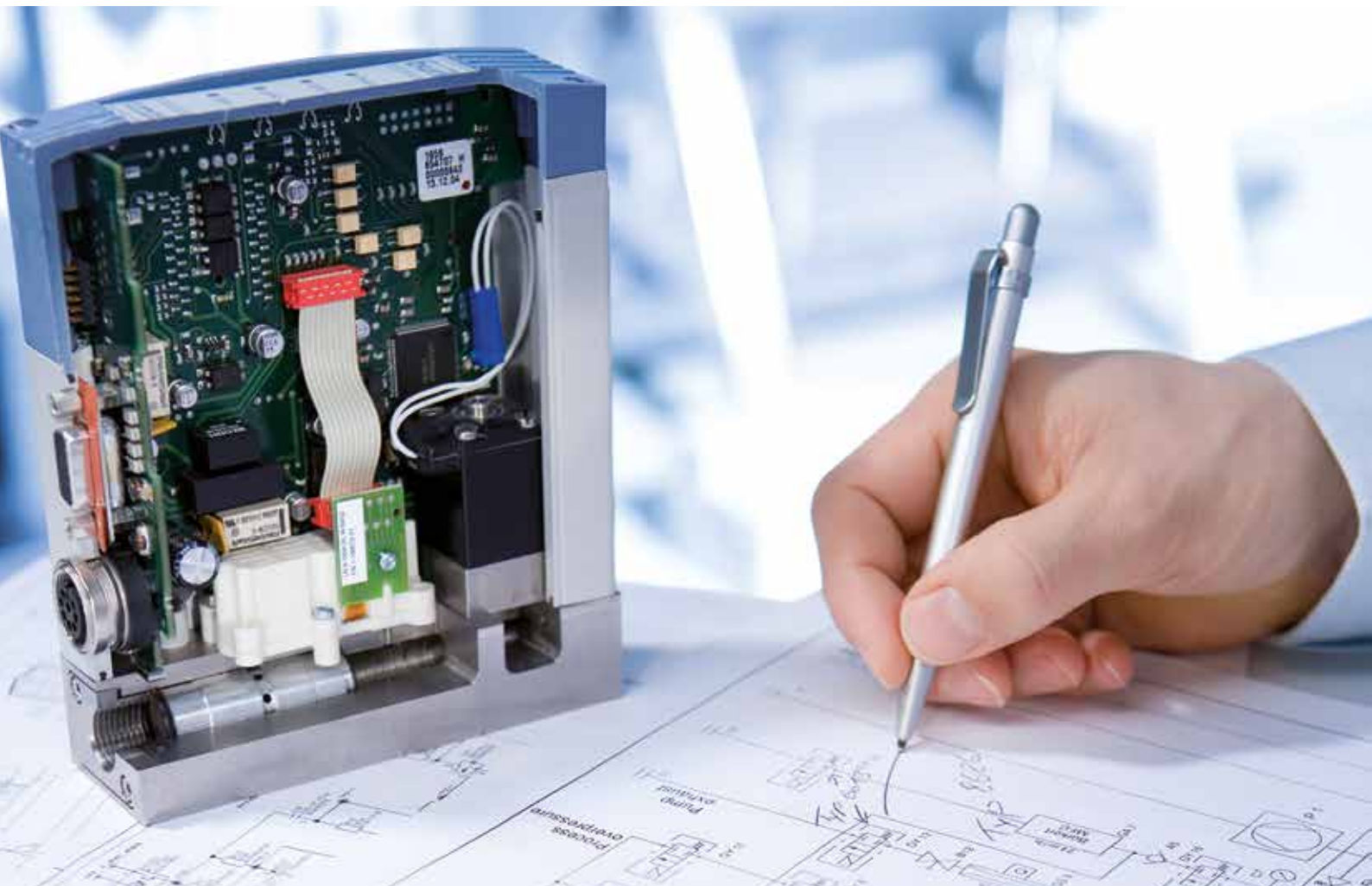

Content

- 3 Introduction
- 4 Fascination Bürkert
- 6 Product Overview
- 10 Measuring Principle
- 11 Mass Flow Controllers – Setup and Functioning
- 19 Industrial Communication
- 20 Device Platform EDIP
- 22 System Solutions
- 24 Typical Applications
- 26 Configuration
- 28 Technical Terms und Units
- 30 Bürkert worldwide

Introduction

The term “gas” has its origin in the Greek word for chaos. Coincidence? Probably not! Gases are peculiar. They are volatile, sometimes reactive, and always expansive. This means that gases have very special handling requirements.

Process gases are indispensable in industrial manufacturing. From coating and hardening surfaces, right through to the fermentation processes used in the pharmaceutical world. Inert gases are used for example to protect packaged foodstuffs against the effect of atmospheric oxygen and in metal processing to prevent the oxidation of welds. Reactive gases on the other hand are used in industrial applications to have a specific influence on selected processes, and also in the research and development of new products. Whatever the application, it is all down to precise regulation, constant control and accurate metering of the gas media, ensuring a consistent and reproducible result, whilst maintaining process security and limiting costs.

And nobody knows this better than Bürkert – because we have been successfully measuring, controlling and regulating fluids for more than 60 years. We cover the entire process loop with an impressive range of product diversity. We have always been particularly focused on the flow of gaseous substances, and as a result of our passion, numerous products have been materialised. Bürkert’s Mass Flow Meters (MFM) and Mass Flow Controllers (MFC) rank among the most sought after components in the business. With a well established position in various processes all over the world, they set the standard in the measurement and control of mass flow rates.

Reproducible accuracy and precision, with a coherent price-performance ratio – these are the exceptional characteristics of Bürkert’s thermal MFMs/MFCs. Our mechatronic devices unite the functionality of several components at once, in an efficient compact structure with no moving components in the gas flow. Compactness and device intelligence make gas handling so much easier.

Form your own image of the efficiency of Bürkert’s MFMs/MFCs. This brochure will get you started with its technical descriptions and a detailed product overview.

Welcome to the Fascinating World of Fluid Control Systems

Measurement and control: When it comes to working with liquids and gases, we are at your side – as a manufacturer of sophisticated products, as a problem-solver with an eye for the big picture, and as a partner offering you reliable advice. Since we started in 1946, we have developed into one of the world's leading suppliers of Fluid Control Systems. At the same time we have kept our status as a family-owned business with a foundation of strong basic values to highlight the way we think and act.

EXPERIENCE

There are things which are not inherently yours. You have to gather them bit by bit. You receive them from others. And you constantly have to acquire them anew. That is what makes them so valuable. Experience is one of those things. For instance, because of our many years of experience with metering and controlling of gases, we can provide our extensive services to you – from consulting, development, and 3D CAD simulating to testing and after-sales service. Whether individual product solutions or a pioneering new system for the entire control process: Benefit from our experience!

COURAGE

Those who only work toward optimising things that already exist will eventually reach the limits – technically, financially, or personally. In order to overcome these limits, courage is needed: the courage to be different and trust one's own ideas; the courage to venture into the unknown, searching for new ways to develop products that have never existed before. We have this courage. By pooling and utilising our competencies across all sectors, you benefit from our cumulative knowledge in Gas Handling applications – whether it is plasma gas control or hydrogen in fuel cell technology.

CLOSENESS

There are things we simply take for granted. Only when they are gone, do we realise how important these things really were. This applies in particular to closeness. Without closeness, it is very difficult to build relationships and a good understanding of one another. As an established medium-sized company, we know that. And that is why we are always there for you. Working with you, we develop the best possible solutions for your projects in the area of Gas Handling. Our global presence in 35 locations enables us to press ahead with technical innovations for our customers around the world.

Bürkert Product Program

We are one of the few suppliers on the market to cover the complete control loop. Our current product range extends from solenoid valves through process and analytical valves to pneumatic actuators and sensors.



Bürkert offers a remarkable range of servo-assisted and direct acting solenoid valves. Read more about them in this brochure.



Bürkert offers unlimited modularity for process control with angle-seat, globe and diaphragm valves in the widest range of configurations.



Here you can find our product range of pneumatic valves, valve units and automation systems as well as information on our control cabinet building.



Here you can find our sensors, transmitters and controllers for measuring and controlling flow, temperature, pressure, level, pH/ORP and conductivity.



The brochure contains an overview of Bürkert miniature valves and micro pumps, which allow for precise and safe handling of small volumes of liquids.



This brochure provides technical background information as well as a detailed product overview for the mass flow controller and meter product range.

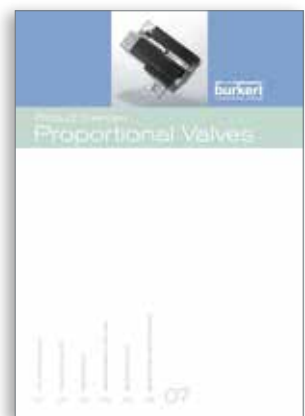

This brochure presents our solenoid control valves including their respective features, functions and typical applications.



Product Overview

All Mass Flow Controller (MFC)/Meter (MFM) work at a nominal voltage of 24V DC, have a low pressure drop and do not require flow conditioning at the inlet or outlet.

			
Type	8626 (MFC)/8006 (MFM)	8710 (MFC)/8700 (MFM)	8715 (MFC)/8705 (MFM)
Full scale ranges (273.15 K, 1013.25 mbar)	20 - 1500 I _N /min (N ₂), MFM up to 2500 I _N /min (N ₂)	0.005 - 10 I _N /min (N ₂)	
Sensor technology	Inline Sensor	Capillary Sensor	
Body material	Stainless steel, aluminium	Stainless steel	
Media	Neutral, non-contaminated gases	Aggressive, toxic gases	
Turn-down ratio	1:50	1:50	
Pressure / bar	10 bar optional up to 20 bar	10 bar	
Gas temperature	-10 to +70 °C	-10 to +70 °C	
Accuracy	± 1.5 % o. R. ± 0.3 % F. S.	± 1.5 % o. R. ± 0.3 % F. S.	
Repeatability	± 0.1 % F. S.	± 0.1 % F. S.	
Settling time	< 500 ms	< 3000 ms	
Protection class	IP65	IP40	
Communication	Standard signal, RS-232 or RS-485, Modbus-RTU (RS485 adapter) PROFIBUS-DP, CANopen	Standard signal, RS-232 or RS-485, Modbus-RTU (RS485 adapter) PROFIBUS-DP, CANopen	RS-232 or RS-485, Modbus-RTU
Special features	Sensor in contact with medium	Sensor not in contact with medium	
	Real gas calibration	Real gas calibration or conversion factor	
	Little sensitivity of the sensor to humidity and particles		



8711 (MFC)/8701 (MFM)



8712 (MFC)/8702 (MFM)



8713 (MFC)/8703 (MFM)

0.01 - 80 l_N/min (N₂)

MEMS Sensor

Stainless steel, aluminium

Stainless steel

Stainless steel, aluminium

Neutral, non-contaminated gases

1:50

10 bar

-10 to +70 °C

± 0.8% o. R. ± 0.3% F. S.

± 0.1% F. S.

< 300 ms

IP40

IP65

IP40

Standard signal, RS-232 or RS-485,
Modbus-RTU (RS485 adapter)
PROFIBUS-DP, CANopenStandard signal, RS-232 or RS-485,
Modbus-RTU (RS485 adapter)
PROFIBUS-DP, CANopenRS-232 or RS-485,
Modbus-RTU

Sensor in contact with medium

Real gas calibration

Little sensitivity of the sensor to humidity and particles

Product Overview

All Mass Flow Controller (MFC)/Meter (MFM) work at a nominal voltage of 24V DC, have a low pressure drop and do not require flow conditioning at the inlet or outlet.

			
Type	8746 (MFC/MFM) ¹ büS / CANopen	8741 (MFC/MFM) büS / CANopen	8742 (MFC/MFM) ¹ büS / CANopen
Full scale ranges (273.15 K, 1013.25 mbar)	20 - 2500 I _N /min (N ₂)	0.01 - 160 I _N /min (N ₂)	
Sensor technology	Inline Sensor	MEMS Sensor	
Body material	Stainless steel, aluminium		
Media	Neutral, non-contaminated gases		
Turn-down ratio	1:50	1:50, optional 1:100	
Pressure / bar	25 bar	10 bar	
Gas temperature	-10 to +70 °C	-10 to +70 °C	
Accuracy	± 1.5% o. R. ± 0.3% F. S.	± 0.8% o. R. ± 0.3% F. S.	
Repeatability	± 0.1% F. S.	± 0.1% F. S.	
Settling time	< 500 ms	< 300 ms	
Protection class	IP65 and IP67	IP20	IP65 and IP67
Communication	CANopen or CAN-based büS ²		
Conformity	USP Class VI, FDA		
Special features	Sensor in contact with medium		
	Real gas calibration		
	Little sensitivity of the sensor to humidity and particles		

1) Type suitable for ATEX Zone 2, Kat. 3, IIC, T4

2) In büS-modus up 32 MFC/MFM can be connected to the fieldbus gateway type ME43. The gateway processes and translates the internal büS communication to industrial fieldbus / Ethernet standards (PROFIBUS DP, PROFINET, Ethernet/IP, Modbus TCP, EtherCAT). Furthermore, the gateway can be extended by I/O modules and as an option a graphic programming interface can be activated.



8745 (MFC/MFM) Standard

20 - 2500 l_N/min (N₂),

Inline Sensor



8741 (MFC/MFM) Standard

0.01 - 160 l_N/min (N₂)

MEMS Sensor

Stainless steel, aluminium

Neutral, non-contaminated gases

1:50

1:50, optional 1:100

25 bar

10 bar

-10 to +70 °C

-10 to +70 °C

± 1.5% o. R. ± 0.3% F. S.

± 0.8% o. R. ± 0.3% F. S.

± 0.1% F. S.

± 0.1% F. S.

< 500 ms

< 300 ms

IP20

IP20

Standard signal, PROFINET, EtherNet/IP, EtherCAT, Modbus TCP

USP Class VI, FDA

Sensor in contact with medium

Real gas calibration

Little sensitivity of the sensor to humidity and particles

The Measuring Principle of Thermal Mass Flow

The physical law is well known – heat always flows towards lower temperatures. So if a body has a higher temperature than its environment, it will give off its heat energy to the neighbouring mass. So our thermal/calorimetric measurement technique utilises this principle, i. e. heat conduction and transportation in gases.

Thermal flow sensors for determining the mass flow rate of gases essentially consist of a heating element and temperature sensors, which can be installed both in and outside the gas flow channel. The heating element heats the gas flowing through, and the temperature sensors detect the dissipated heat volume.

The respective dissipated heat energy is a function of the current mass flow. The mass flow literally defines the weight of the flowing medium, more specifically – this is the weight of the gas that flows through the device in a specific time unit. This is usually given in kg/h, g/s or mol/s. In contrast to the mass flow, the volume flow defines the volume of the gas (measured in m³/h, l/min or ml/s) that flows through the device in a specific time unit. If you measure the gas volume, you must know additional values such as temperature and pressure so that you can make comparisons. So there are good reasons for measuring the mass flow and not its volume flow – because gases are compressible. Depending on its pressure and temperature, both the density and therefore its volume will change. In many applications mass flow measurements therefore are more relevant than volume flow measurements.

MFMs/MFCs are ideal for application areas where high precision and reproducibility are required – such as in burner technology, coating systems and fuel cell applications. In addition it is possible to use MFMs/MFCs where the use of volume flow units are standard. Why? Because if we know the standard density, we can calculate the standard volume flow directly from the mass flow value. The rate of the volume flow then refers to the standardised condition for comparability reasons (in acc. with DIN 1343, see “Appendix” on page 28).

The MFMs/MFCs presented in the following pages can be calibrated for both mass flow and volume flow (see “Calibration” on page 16).

Mass Flow Controllers – Setup and Functioning

All Mass Flow Controllers from Bürkert are compact devices that control the mass flow of gases. They control a preset flow rate reference value – regardless of disturbance variables such as pressure fluctuations or temporary occurring flow resistances, e. g. as a result of filter dirt. MFCs consist of the following components: flow sensor, electronics and a solenoid control valve as an actuator. The reference value setting is made electrically via analogue signal or fieldbus. The actual value measured by the sensor is compared in the controller with the reference value. The controller gives a pulse-width modulated voltage signal to the actuator as a correcting variable and varies it according to the registered control deviation. The actual value is also transmitted externally via an analogue signal or fieldbus. It is therefore provided to the user for controlling and analysing. With its easy installation, the compact structure of the Mass Flow Controller ensures the convenient operation of a complete (closed) control loop. Additional work and costs, e. g. wiring and harmonising individual components, incorporating pipe lengths (inlet/outlet pipe for flow conditioning), are ruled out. In case a process requires only measurement of a mass flow and no control: Bürkert Mass Flow Meters are the right choice. The only difference compared to MFCs is that the actuating valve does not exist.

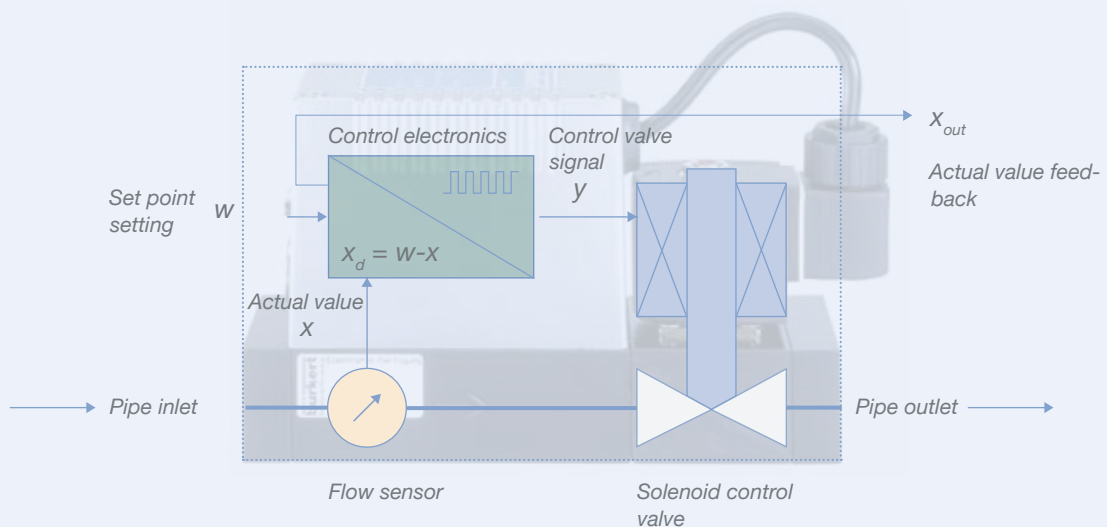

Basic principle closed control loop

Inline Sensor

Types 8626/8006, 8745, 8746

The Inline sensor works in the CTA operating mode (Constant Temperature Anemometer), whereby an electrical heating resistance (R_s) and a measurement resistance (R_T) are regulated at a constant temperature difference. Both resistances are directly placed in the flow channel; three more resistances are outside. Together they are all connected into a measurement bridge. The first resistance in the gas flow (R_T) measures the fluid temperature. The second, low ohmic resistance (R_s) is constantly heated just enough so that a fixed preset overtemperature is maintained for the fluid temperature (measured with R_T). The heat current required for this is used as the measurement for the gas flowing through the channel. Appropriate flow conditioning in the MFC ensures that the mass flow can be very precisely derived. Because of the arrangement of the R_s and R_T resistances directly in the flow channel, the devices have exceptional characteristics, with response times of just a few hundred milliseconds with set point or actual value changes. The sensor arrangement ensures low contamination susceptibility.

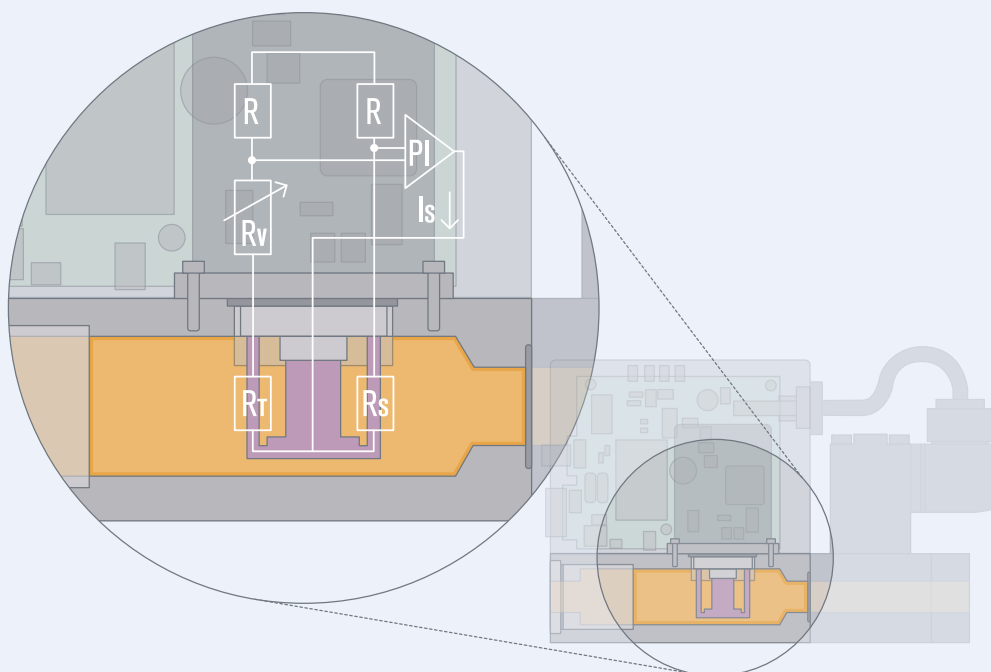

Functional schematic of Inline sensor

MEMS Sensor

Types 8711/8701, 8712/8702, 8713/8703, 8741, 8742

In contrast to the Inline sensor, with which the mass flow in the main channel is measured, the MEMS sensor determines the values directly in a secondary channel. In detail: A laminar flow element brought into the main channel ensures the necessary pressure drop. This causes a small part of the total flow rate to be diverted into a parallel secondary channel. A silicon chip with a membrane is fitted to the wall of the flow channel for sensing the flow rate. This membrane includes (in MEMS technology) a heating resistance and two symmetrical temperature sensors – upstream and downstream. If the heating resistance is now held at a constant temperature, the differential voltage of the temperature sensors applies as the measurement for mass flow rate of the gas flowing over the chip in the flow channel. The low thermal mass of the temperature sensors and their direct contact with the flow have specific advantages including extremely quick response to flow rate changes. The MFC can control set point or actual value changes within hundred milliseconds and it maintains its high sensitivity, even with the smallest flow rates.

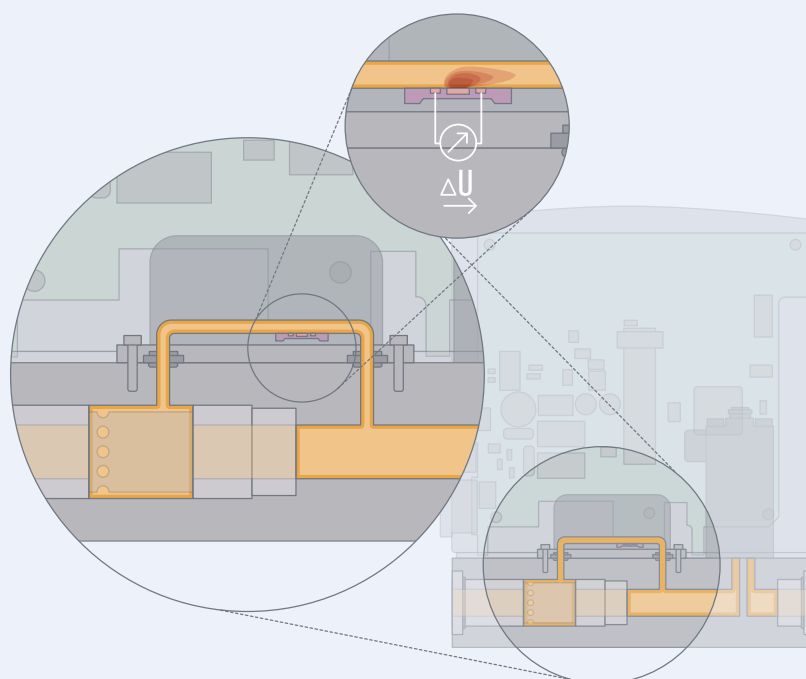

Functional schematic of MEMS sensor

Capillary Sensor

Types 8710/8700, 8715/8705

As with the MEMS sensor, a laminar flow element also causes a pressure drop in the main channel with the capillary sensor. A part of the total flow rate flows through a parallel running secondary channel. The decisive differences: the capillary sensor has no direct contact with the medium. The stainless steel capillary is surrounded by two temperature-dependent resistances, which form the half-bridge of a Wheatstone bridge circuit. If gas now flows through the capillary, its gas flow carries heat in the flow direction from R_1 to R_2 . The R_1 resistance value falls; while the value of R_2 increases. If the bridge circuit is fed with constant current, its outlet voltage changes proportionately to the resistance difference. The measuring range then shows a linear dependency between the outlet voltage and mass flow rate of the gas flowing through. This linear dependency even enables the use of gases that the sensor is not calibrated for. The flow rate value is adjusted accordingly to the current medium using a conversion factor. The resulting simplified calibration and the correct material selection for the gas ensures the capillary sensor's suitability for the use with aggressive gases.

The measurement dynamic depends on the wall properties of the stainless steel capillary. It acts to a certain degree as a thermal barrier. The capillary sensor achieves response times of just a few seconds. This is sufficient for many applications with aggressive or toxic gases.

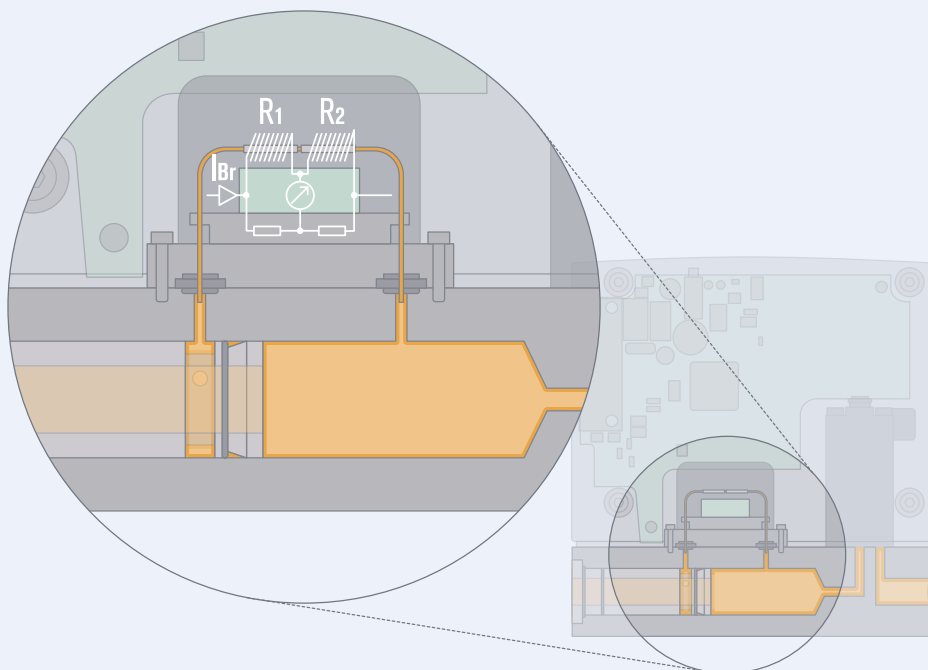

Functional schematic of the capillary sensor

Solenoid Control Valve

Solenoid control valves are electromagnetic control valves. They open to specific stroke positions – depending on the control signal. Two forces counter one another in the valve: one a spring, and the other generated by a magnetic field. In the power off state the pretensioned spring presses the plunger directly on to the valve seat, and the valve stays closed. If power is supplied to the coil a magnetic field is produced, which lifts the plunger against the spring force. The valve opens and the medium (gas) flows. The level of the coil current directly influences the magnetic force, the plunger stroke, the valve's opening degree, and therefore the amount of gas that flows through the valve. This simple, direct-acting construction keeps the control valves small, compact and cost-optimised. These are the properties that make solenoid control valves especially ideal for closed process control loops, where their precisely reproducible control positions and short response times make them particularly impressive. The orifices of the valves are calculated from these parameters: required nominal flow rate (Q_{nom}), the pressure conditions of the application, temperature and density of the operating gas (see: "Configuration" on page 26). MFCs with solenoid control valves in the orifice range of 0.05 mm to 12 mm have a wide full scale range. Besides electromagnetic control valves also motorized control valves are used. With a range of 2 mm to 25 mm these motor valves are especially suitable for applications with high operating pressures and/or high flow rates.

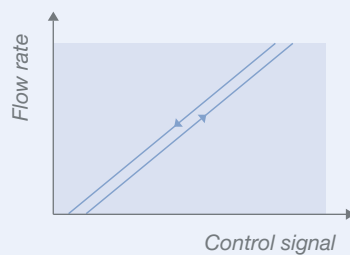

Characteristic of an electromagnetic control valve

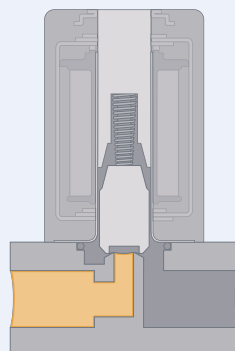

Closed state

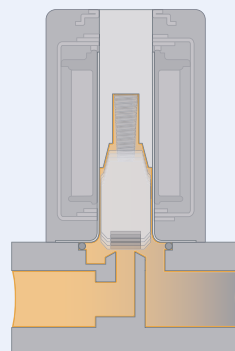

Controlled inclined position

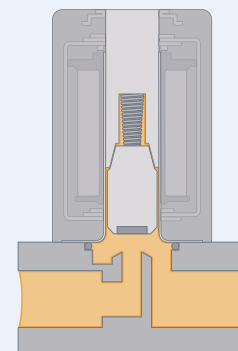

Opened state

Functional principle of direct-acting electro pneumatic solenoid control valves

Calibration

The sensor's measuring signal range is unambiguously assigned to the flow rate control or measuring range with the calibration. Extremely precise flow references are used to set the flow rate values and record the respective sensor signals. If the flow curve is registered, the electrical inputs and outputs can be calibrated, i. e. the flow range can be assigned to the signal range. Mass Flow Meters and Controllers are generally calibrated for a specific gas. Another gas can only be reliably controlled or measured when a second calibration curve has been stored. Exceptions to this are gases with similar properties, such as nitrogen and oxygen. A conversion factor across the entire flow range is sufficient. With devices with capillary sensors, access to conversion factors is sufficient with most gases because of the very low accuracy losses. Essentially every kind of gas mixture can be measured if its composition remains constant. MFMs/MFCs are often calibrated for the following gases: air, nitrogen, oxygen, argon, helium, hydrogen, methane, natural gas, propane, ammonia, carbon dioxide, carbon monoxide, sulphur dioxide or other various gas mixtures. If the highest precision is required, calibration with the operating gas (real gas calibration) is recommended in most cases. Aggressive gases cannot be real gas-calibrated.

The flow references used in calibration test stands are based on DAKKS (Deutsche Akkreditierungsstelle GmbH) and NIST (National Institute of Standards/USA). The DAKKS is a signatory of a global recognition agreement for calibration standards (MRA – Mutual Recognition Agreement).

burkert
FLUID CONTROL SYSTEMS

**Mass Flow Controller Type 8626
Test Report**

Order No.: 71072757
Ident No.: 00266854
Serial No.: 001000
Designation: 8626-C2000-LUP-E-UJ-GM82-ALAA-D-03.0
Firmware: 00651816 Revision A.08.00.00

Device configuration is described below
Analog input: 0 - 5 V
Analog output: 0 - 5 V
Digital communication: RS322

We certified that the delivered product has successfully passed the following tests

Checked item	Specifications	Results
Default values		Test OK
Binary outputs	Number: 2	Test OK
Binary inputs	Number: 3	Test OK
Analog input	Voltage	Test OK
Analog output	Voltage	Test OK
Analog input	Current	Test OK
Analog output	Current	Test OK
Leakage		Test OK
Flow calibration medium	see "Flow Protocol Medium 1"	Test OK

Bürkert S&S quality department certifies that the measuring instruments and the test equipment which are used to check the finished goods or sub-assemblies are periodically calibrated or checked according to the internal procedure W 32 according to the quality standard ISO 9001:2008 version 09/08
Bürkert S&S reference equipment in the measuring system are traceable to national standards via accredited calibration lab.

burkert
FLUID CONTROL SYSTEMS

**Mass Flow Controller Type 8626
Flow Protocol Medium 1**

Order No.: 71072757
Ident No.: 00266854
Serial No.: 001000

Operating Medium: Air
Calibration Medium: Air
Nominal Flow Rate: 200.00 Nl/min
Installation Position: vertical, flow upwards

Temperature: 25.16 °C
Inlet Pressure: 4.00 bar (g)
Leak-tight Pressure: 10.00 bar (g)

Flow Reference: 06-45-0304_003
Mass Flow Meter 8506
ID 164458, SN 010200, 010201, Range 0-500 Nl/min

Flow Rate Data:

Device [Nl/min]	Reference [Nl/min]	Deviation [% F.S.]	Allowed Deviation [% F.S.]
0.0	0.0	0.00	0.30
50.0	49.9	-0.05	0.67
100.0	99.9	-0.10	1.00
150.0	150.2	+0.08	1.43
200.0	199.7	-0.16	1.80

DATE: 04/04/2014 TESTER: 04000202

This report is generated by an electronic system and is valid without signatures. These data refer to the time and conditions of calibration. Reference conditions (Pressure: 273.15 K, 101.325 kPa).

A calibration certificate is created for each MFM/MFC after calibration. Two calibration certificates are provided for MFMs/MFCs supplied for the use of two gases or for devices with a wider measuring span.

Digital Control Electronics

The electronic microprocessor system processes the set point and actual flow rate values. In addition it also controls the actuator (solenoid control valve). Furthermore, the control electronics convert the sensor signal into a value that corresponds to the actual flow rate value using a calibration curve stored in the device. The controller processes the control deviation between set point value and actual value in accordance with a PI action, from which it calculates the correcting variable, with which the actuator is controlled. The control parameters are set beforehand with the factory calibration. Because of the specific properties of each and every control process, the controller works with process-dependent amplification factors, which are automatically determined with an auto-optimisation routine (Autotune). Control dynamics, filter level and damping of the returned actual value signal the communication software helps to adjust these settings later on. Depending on the device model, the set point value and actual value signals can be predefined and fed back either by analogue or digital technics: analogue via standard signal interface or digital via RS-232/RS-485, fieldbus interface or Industrial Ethernet. In modern industrial plants the communication with fieldbuses and Industrial Ethernet has often remarkable advantages. For example the wiring costs can be significantly reduced using these technologies and additional information regarding status and diagnosis of the devices can be communicated in a highly dynamic manner.

The microprocessor controlled electronics provide significant benefits: they reduce drift and offset occurrences of the components and enable software-based control of the most important processes (flash-programmed and update-enabled). The relevant data for this (calibration curves, correcting functions, control functions, etc.) can be stored in the memory.



Industrial Communication – with Fieldbus and Industrial Ethernet

With the introduction of fieldbuses in the 1980s, information technology came into play at the field level of automation. Manufacturer-driven, fieldbus systems arrived on the market one after another. Well known and wide spread representatives are PROFIBUS and CANopen. Basic advantages to conventional, hardwired architectures include reduced wiring costs (hardware) and easy integration of single components into an industrial plant (software). These are key factors in process automation.

Strong competition for fieldbus systems is Industrial Ethernet. The strongest representatives here are Ethernet-IP, PROFINET, Modbus-TCP and EtherCAT. Compared to conventional fieldbus systems, Industrial Ethernet offers additional opportunities in large and highly automated factories:

- Real-time data can be transmitted virtually simultaneously over a common medium.
- Integration of almost unlimited number of nodes with equal rights is possible.
- Large-area networks and efficient transmission of extensive data quantities can be realized.
- Various transmission media can be combined.

Bürkert's broad MFC/MFM product range offers the adequate solution for all industry requirements: analogue and digital communication based on RS232 / RS485, as well as all standard fieldbus interfaces and industrial Ethernet standards.

The büS versions (büS is based on CANopen bus) of MFC types 8741, 8742 and 8746 are especially for applications with several MFC/MFM control loops. Up to 32 MFC/MFM can be connected to the fieldbus gateway type ME43. The gateway processes and translates the internal büS communication to industrial fieldbus / Ethernet standards (PROFIBUS DP, PROFINET, Ethernet/IP, Modbus TCP, EtherCAT). Furthermore the gateway can be extended by an I/O module and as an option a graphic programming for type 8922 can be activated. This system offers maximum performance and flexibility with minimum costs for the MFCs/MFMs. Bürkert supplies the project specific configuration files of the field bus coupler which allows reduced efforts for commissioning and project planning at customer side. All MFC/MFM of the 874x-series are part of the Bürkert device platform EDIP (Efficient Device Integration Platform, see "EDIP" on page 20).

Functionality of a büS system consisting of a programmable logic controller (PLC), gateway type ME43 and MFC/MFM types 874x büS/CANopen. Fieldbus or Industrial Ethernet signals from the PLC are transferred by the gateway into the proprietary büS. Optionally, I/O modules and a graphic programming can be added to the gateway via a modular backplane.

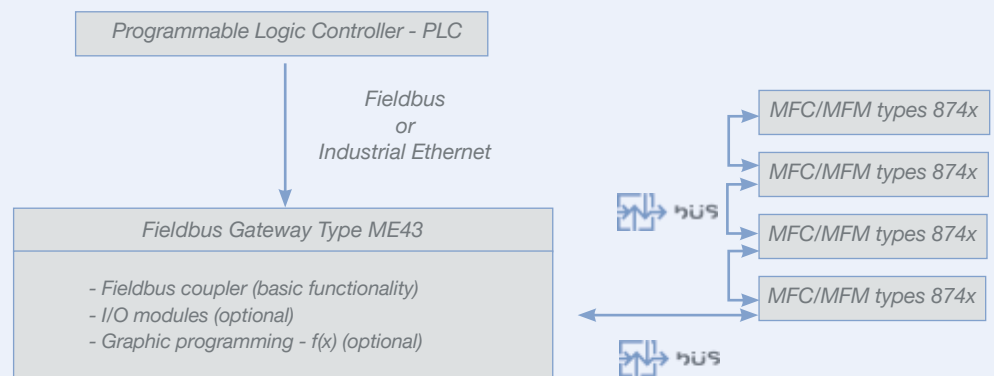

EDIP

(Efficient Device Integration Platform)

The term EDIP stands for Efficient Device Integration Platform. It is the new Bürkert device platform which standardizes the operation, communication and interfaces of many process instruments (e.g. sensors, mass flow controllers). With EDIP all bÜS devices from Bürkert can be integrated into the proprietary bÜS system and can be operated with the standardized software tool: Bürkert Communicator.

EDIP offers significant advantages for process integration:

- Standardized interface between field devices - bÜS
- Software tool for configuration/parameterization of all devices - Bürkert Communicator
- Modular architecture allows easy generation of variants
- Field devices interact with each other and exchange information
- New modules register automatically in the bÜS system

EDIP consists basically out of the three columns: communication, software and hardware.

Communication – bÜS

The proprietary bÜS (Bürkert system bus) is a standardized digital interface of Bürkert devices. It mainly complies with CANOpen, and is always downward compatible to it. The following key characteristics make the bÜS interface and protocol more user-friendly:

- There is no master in the system bus. All participants have equal rights and listen to the data, which is relevant for them
- Addressing of bÜS participants happens automatically
- Consumers of messages further monitor their suppliers and give an alarm if needed

Hardware – Modular Structure

The MFC/MFM Types 8741, 8742 and 8746 are connect to one central interface, the fieldbus gateway Type ME43. The gateway is the only interface to the PLC and thus eases the commissioning of the system significantly. The field devices (e.g. MFC/MFM, but additionally several Bürkert products feature the same bÜS interface) can be connected without any difficulties. The ME43 gateway can be extended with I/O modules Type ME44 via a backplane thanks to the modular construction concept. This enables additional functionalities, like adding shut-off valves to the bus system or reading analog sensor values and integrate them into the bus network. All together, we call the MExx construction System Connect.

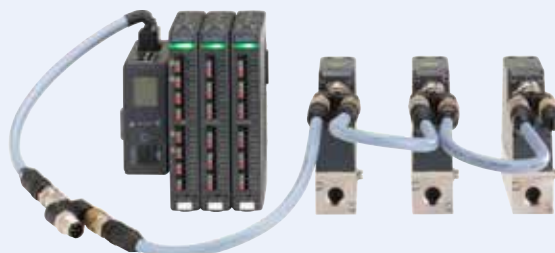

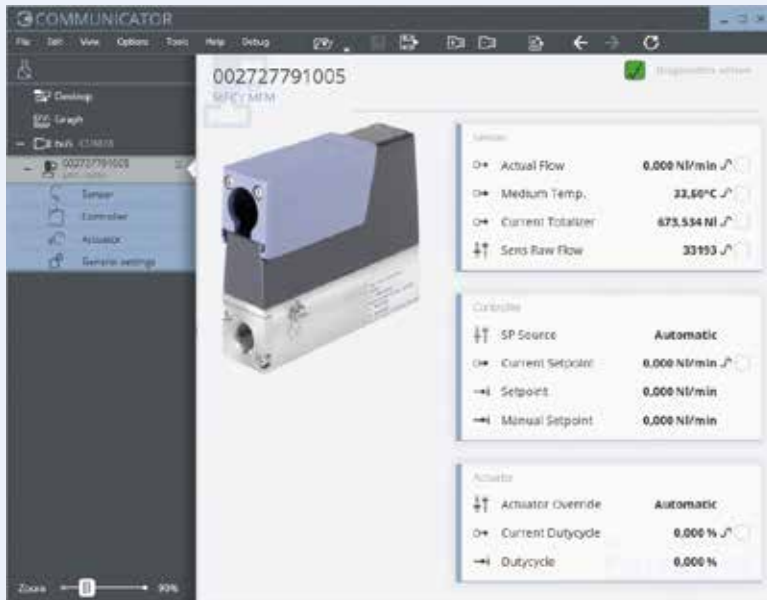

User interface of the Bürkert Communicator. The graphical programming interface (f(x)) is integrated into this software. The f(x) allows to program customized system control functions – e.g. for gas blending.

Software – Bürkert Communicator

The comprehensive software tool Bürkert Communicator is freely available on the Bürkert website and can be run under MS-Windows. It allows the user to parameterize device settings or watch process controls. A computer can be connected to the process instruments via an USB adapter (bÜS stick).

General functions of the Bürkert Communicator:

- Graphical monitoring of process data
- Registration and storage of process data
- Firmware updates and cloud connection of bÜS devices
- License management for activation of special functions
- Device driver as plug-in
- Remote maintenance via Ethernet
- Many languages expandable
- Graphical programming type 8922 - f(x): interface for the control of the bÜS system (see “graphical programming” on page 22)

MFC/MFM specific functions of the Bürkert Communicator:

Parametering

- With multiple calibrations: Selection of an operating gas
- User-defined re-calibration
- Setting the control dynamics
- Setting a set point profile
- Definition of functional groups for input and output values
- Factory reset

Diagnosis and Service

- Control loop analysis
- Logbook for error messages
- Display device status
- Autotune function: automatic valve control range adjustment to the process conditions
- Setting the transmission time for cyclic data

Graphical programming System control with User f(x) - Type 8922

Industry processes include many recurring sequences. Examples are the controlling of mixing processes for gases, recording the state of a system, or error monitoring. The graphical programming simplifies the implementation of functionalities in industrial plants. The programming of the higher-level PLC is simplified due to outsourcing of specific control loops. The f(x) program allows setting up control loops via simple graphical programming within the Bürkert Communicator software.

One example of the program use is the control of gas mixtures. If there is an existing program, it can be imported into the system. The program monitors the mass flow of one system participant. Based on that value the program e. g. calculates the flow ratio (in %) for the other participants and regulates their mass flow according to the given set point values.

In addition, recording of the state of the system and error monitoring can be implemented in the program. Further input and output signals (analogue or digital) can be processed if the system contains the appropriate I/O modules.

Using a MEXx system with customized software enables the user to control all functionalities of the integrated bus capable field devices. This is usually not possible with manufacturer independent standard gateways or PLCs.

Bürkert Communicator

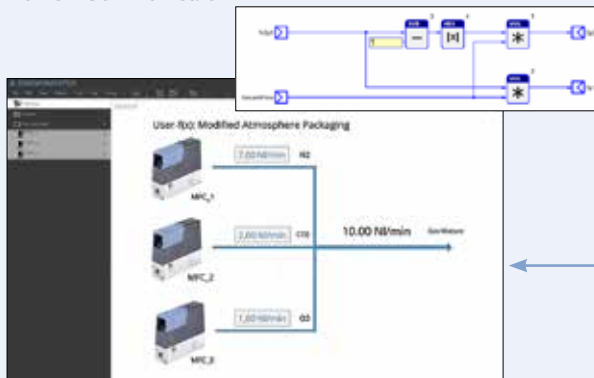

Fieldbus gateway ME43



MFC



MFC 1



MFC 2



MFC 3

Functionality of a gas mixing application for the food and beverage industry. To improve the shelf life of a package the composition of the internal atmosphere is modified. The User-f(x) program controls the ratio of the different gases.

System Solutions

Gas handling applications vary, the technology is complex and the offering range is diverse. So obviously it is always easier if you have a partner at your side that has a long standing reputation that goes far beyond the development of high tech and innovative products. For more than 10 years, Bürkert has been established as a global leader in the provision of system solutions.

The advantages of Bürkert system engineering capabilities are convincing. With one single order number you can have a complete package to satisfy all your specific requirements. You are therefore free of procurement and installation work – and consequently the respective costs. For example Bürkert system solutions could consolidate a complicated series of valves, pipework and their respective connections, into a simplified and smart solution. The entire system is checked to ensure it is sealed tight and has fewer sealing points, which provides safety and security! In gas control applications numerous components interact with one another: These include solenoid valves, MFCs, sensors, switches, block-integrated check valves, integrated and replaceable filter elements and manual valves. These are all components that demand space. But a modular, compact installation is guaranteed if the entire system and technology come from one single source. With Bürkert's modular system engineering you have all the necessary, future proof options, because Bürkert's modular systems make later upgrades incredibly easy. The ground-breaking device platform EDIP allows to realize both hardware and software developments in minimum time. The modular structure enables almost any combination of single components.

Bürkert provides system solutions to uncomplicate your world, through our experience, expertise and holistic competence.



System example: Additional elements like manual valves, pressure transmitter or manometers can be integrated on customer's request

Typical Applications

The following illustrations demonstrate possible areas of application for MFMs/MFCs.

Flame Control

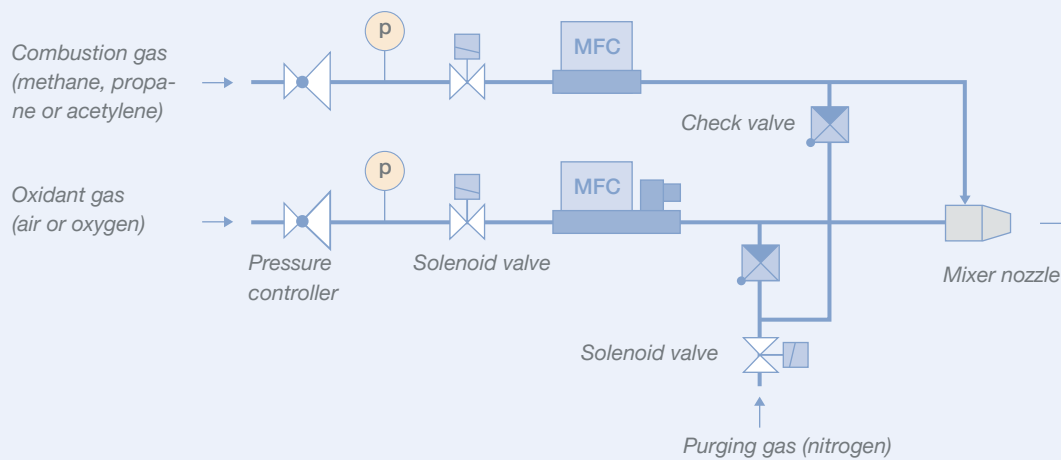

MFCs and MFMs are used to provide combustion gas and oxygen in precise ratios.

Plasma control

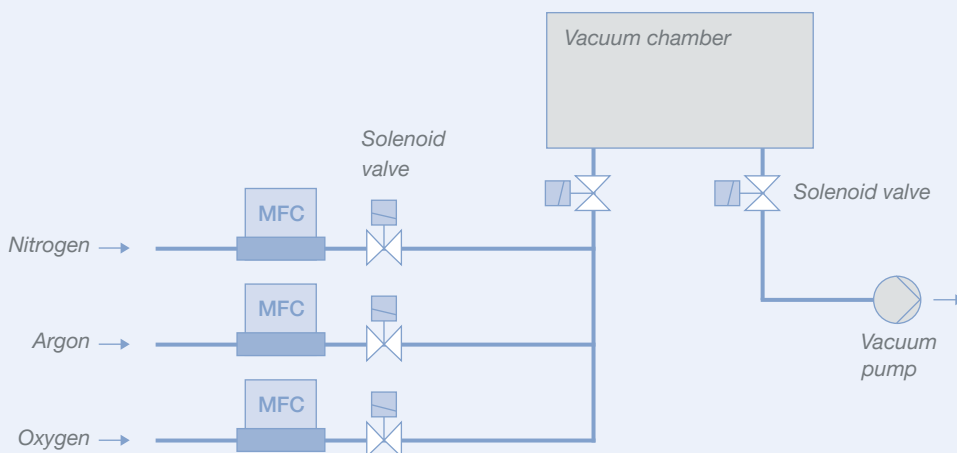

MFCs precisely dose gas and gas mixtures into a vacuum chamber and therefore enable products to be processed in a plasma atmosphere.

Atmosphere Control

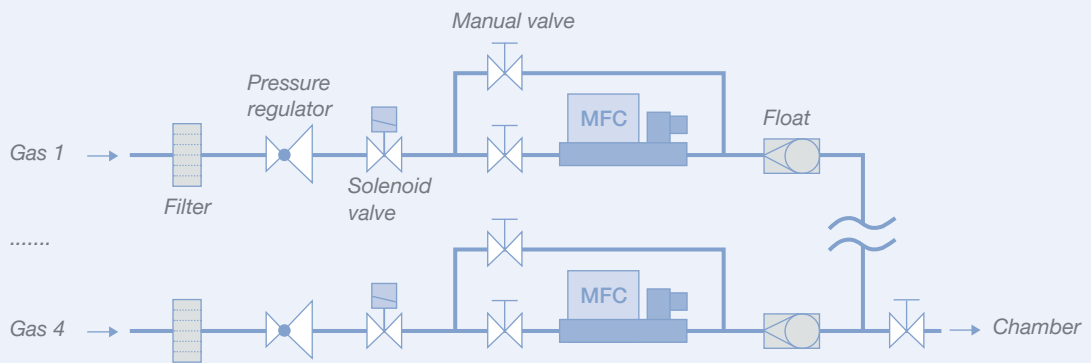

The MFCs provide defined atmospheres to guarantee reproducible processes. The atmosphere volume can range from a specific point on a weld seam to the chamber volume of a hardening furnace.



Configuration

Is the gas going to be controlled or just measured?

MFC contain a solenoid control valve that sets the desired gas flow rate. MFMs however, only provide the current gas flow rate in the form of an actual value signal.

What medium is to be controlled, dosed or measured?

MFM/MFC can be calibrated for a gas or gas mixture. If it is a gas mixture, an exact composition in percentages is important for configuring and calibrating the device. MFM/MFC with Inline or MEMS sensors need to be calibrated using the operating gas (real gas calibration) for both gases and gas mixtures. MFM/MFC with capillary sensors have a linear correlation between flow rate and measurement signal, allowing calibration with a neutral gas. The determined flow rate is corrected during operation using the conversion factor of the respective operating gas or gas mixture. The material compatibility of the MFM/MFC components must be ensured. The relative humidity can be almost 100%. A liquid state must, however, always be prevented. Particulate matter should be excluded with pre-filtering.

What process data is available?

For an optimum MFM/MFC configuration some application data has to be available. Firstly the maximum flow rate (Q_{nom}); according to the medium's normal density ρ_N . This can be determined with the known gas mixture composition. Next we require the medium temperature (T_1) and the pressure values with the flow rate (Q_{nom}) – measured immediately before and after the MFM/MFC (p_1, p_2). The MFM/MFC k_v value is calculated with all this data (please see a data sheet of solenoid control valves). For the MFC's control properties it is important that the calculated MFM/MFC k_v value is greater than the k_v value of the overall system. With a too high k_v value, the resolution and therefore control qualities of the valve are impaired. If the setting is too low the MFC cannot achieve the required flow rate. The MFC authority (valve authority; please see appendix) should not be less than 0.3 ... 0.5. By dividing the maximum flow rate (Q_{nom}) by the span, the minimum flow rate (Q_{min}) can be calculated. For a guaranteed close tight function in all operating states, the maximum inlet pressure (p_{1max}) is required.

How do I communicate the set point and process value?

The control electronics are set up digitally. The interfaces can be configured as either analogue or digital. There is a choice of industry standard analogue signals, digital communication RS-232 or RS-422, fieldbus (PROFIBUS-DP, CANopen, Modbus-RTU) or Industrial Ethernet (PROFINET, Ethernet-IP, Modbus-TCP).

8711



Note
You can fill out the fields directly in the PDF file before printing out the form.

MFC/MFM applications - request for quotation

▶ Please fill out and send to your nearest Bürkert sales centre* together with your inquiry or order

Company	Contact person
Customer No.:	Department
Address	Tel./Fax
Postcode/Town:	E-mail

MFC-application
 MFM-application
 Quantity
 Required delivery date

Medium data

Type of gas (or gas proportion in mixtures)

Density [kg/m³] ¹⁾

Medium temperature [°C or °F] °C °F

Moisture content [g/m³]

Abrasive components / solid particles
 no
 yes as follows

Fluidic data

Maximum flow Q_{max}
 l/min ¹⁾
 cm³/min ¹⁾
 m³/h ²⁾
 cm³/min (sccm) ²⁾
 kg/h
 l/min (slpm) ²⁾

Minimum flow Q_{min}
 l/min ¹⁾
 cm³/min ¹⁾
 m³/h ²⁾
 cm³/min (sccm) ²⁾
 kg/h
 l/min (slpm) ²⁾

Inlet pressure at Q_{max} p₁ = barg

Outlet pressure at Q_{max} p₂ = barg

Max. inlet pressure p_{max} barg

Pipe run (external-Ø) metric, mm imperial, inch

MFC/MFM-port connection
 without screw-in fitting
 1/4" without screw-in fitting (DIN ISO 228/1)
 1/4" NPT-thread (ANSI B1.2)
 with screw-in fitting
 sub-base version

Installation
 horizontal, valve upright (Standard) horizontal, valve reclined
 vertical, flow from above vertical, flow from below

Ambient temperature °C

Material data

Body material
 Aluminum
 Stainless steel

Seal material
 FKM
 EPDM
 other:

Electrical data

Output/input signal

with standard signal		with fieldbus
output	input	
<input type="radio"/> 0-5 V	<input type="radio"/> 0-5 V	<input type="radio"/> PROFIBUS-DP
<input type="radio"/> 0-10 V	<input type="radio"/> 0-10 V	<input type="radio"/> DeviceNet
<input type="radio"/> 0-20 mA	<input type="radio"/> 0-20 mA	<input type="radio"/> CANopen
<input type="radio"/> 4-20 mA	<input type="radio"/> 4-20 mA	

¹⁾ Please quote all pressure values as overpressures with respect to atmospheric pressure [barg]

1) at 1.013 bar(a) and 0°C 2) at 1.013 bar(a) and 20°C

To find your nearest Bürkert facility, click on the orange box →

www.burkert.com



In case of special application conditions, please consult for advice.

Subject to alterations © Christian Bürkert GmbH & Co. KG

00050_EU-en_00891804

DTS 1000017527 EN Version: F Status: RL (released | freigegeben | valide) | printed: 06.05.2009

Technical Terms und Units

Full scale range/Nominal flow Q_{nom}

The full scale range is the range of possible full scale values.

The lowest value is the lowest possible full scale value/nominal flow rate; the highest value is the highest possible full scale value/nominal flow rate. The figures refer to defined reference conditions (e. g., standard litre per minute or standard cubic centimetre per minute).

Operating medium/Calibration medium

The operating medium is generally used for calibration; in exceptional cases a reference gas (e. g., nitrogen) is used.

Span

Given as a ratio, e. g. 1:50. Ratio of the smallest controllable flow rate value to the nominal flow rate.

Settling time

Time that the MFC requires to achieve 95 % of the difference between the old and the new flow rate value after a set point change; given in ms (milliseconds).

Response time

Time the MFM needs to achieve 95 % of the new value after a sudden flow rate change from Q_1 to Q_2 .

$$Q_{MFM}(t_{95}) = Q_1 + 0.95(Q_2 - Q_1)$$

Accuracy

Given in $\pm x\%$ of reading $\pm y\%$ of full scale. The first value is a relative percentage; the second is a basic percentage.

Repeatability

Given in $\pm x\%$ of full scale. Repeatability is a mass for variation of actual values that result with repeated setting of a certain set point.

k_v factor (flow rate coefficient)

The k_v value is also called flow rate factor or flow rate coefficient. It is a unit for the achievable flow rate of a fluid or a gas through a valve and is used for selecting and dimensioning valves. The value is given in m^3/h . It corresponds with the water flow rate through a valve (in m^3/h) at a pressure difference of 1 bar and a water temperature of 5 - 30 °C.

c_v factor (flow rate coefficient)

Similar to the k_v factors, based, however, on the imperial measurement system. Given in US gallons per minute, at a pressure drop of 1 psi and 60 °F temperature.

$$c_v = k_v * 1.17$$

Normal conditions (DIN 1343)

Normal conditions are defined at

$$p_N = 1.013 \text{ bar absolute}$$

$$t_N = 0 \text{ °C (273 K)}$$

Standard conditions

Standard conditions are defined at

$$p_S = 1.013 \text{ bar absolute}$$

$$t_S = 20 \text{ °C (293 K)}$$

Density

Density (ρ) provides the correlation between mass flow (\dot{m}) and volume flow (\dot{V}). The pressure and temperature conditions, the density is referred to, must be considered here (see above)

$$\rho = \dot{m}/\dot{V}$$

Valve authority (χ)

$$\chi = (\Delta p)_{V0} / (\Delta p)_0$$

$(\Delta p)_{V0}$ = MFC pressure loss at fully opened valve

$(\Delta p)_0$ = System pressure

Flow rate (volume)	m ³ /h	dm ³ /h	dm ³ /min	cm ³ /h	cm ³ /min	cu ft/h	cu ft/min
1 m ³ /h =	1	10 ³	16.67	10 ⁶	16.67*10 ³	35.32	58.87*10 ⁻²
1 dm ³ /h (l/h) =	10 ⁻³	1	16.67*10 ⁻³	10 ³	16.67	35.32*10 ⁻³	58.87*10 ⁻⁵
1 dm ³ /min (l/min) =	0.06	60	1	60*10 ³	10 ³	2.119	35.32*10 ⁻³
1 cm ³ /h (ml/h) =	10 ⁻⁶	10 ⁻³	16.67*10 ⁻⁶	1	16.67*10 ⁻³	35.32*10 ⁻⁶	58.87*10 ⁻⁸
1 cm ³ /min (ml/min) =	60*10 ⁻⁶	0.06	10 ⁻³	60	1	21.19*10 ⁻⁴	35.32*10 ⁻⁶
1 cu ft/h (cfh) =	28.32*10 ⁻³	28.32	0.472	28.32*10 ³	472	1	16.67*10 ⁻³
1 cu ft/min (cfm) =	1.69	1.69*10 ³	28.32	1.69*10 ⁶	28.32*10 ³	60	1

Flow rate (mass)	kg/h	g/h	g/min
1 kg/h =	1	10 ³	16.67
1 g/h =	10 ⁻³	1	16.67*10 ⁻³
1 g/min =	0.06	60	1

Pressure	bar	mbar	Pa	Torr	psi
1 bar =	1	10 ³	10 ⁵	750.1	14.505
1 mbar =	10 ⁻³	1	10 ²	750.1*10 ⁻³	14.50*10 ⁻³
1 Pa = 1 N/m ² =	10 ⁻⁵	10 ⁻²	1	750.1*10 ⁻⁵	14.50*10 ⁻⁵
1 Torr = 1 mmHg =	1.33*10 ⁻³	1.33	133	1	19*10 ⁻³
1 psi = 1 lb/in ² =	68.9*10 ⁻³	68.95	68.96*10 ²	51.71	1

Temperature	°C	°F
	-10	14
	0	32
	10	50
	20	68
	30	86
	40	104
	50	122
	60	140
	70	158
	80	176
	90	194
	100	212

Bürkert – Close to You

For up-to-date addresses
please visit us at
www.burkert.com.

Austria
Belgium
Czech Republic
Denmark
Finland
France
Germany
Italy
Netherlands

Norway
Poland
Portugal
Spain
Sweden
Switzerland
Turkey
United Kingdom

Russia



Canada
USA

Argentina
Brazil
Uruguay

South Africa

United
Arab
Emirates

Australia
New Zealand

China
Hong Kong
India
Japan
Korea
Malaysia
Philippines
Singapore
Taiwan



bürkert
FLUID CONTROL SYSTEMS

Bürkert Fluid Control Systems
Christian-Bürkert-Straße 13-17
74653 Ingelfingen
Germany

Tel. +49 7940 10 0
Fax +49 7940 1091204

info@burkert.com
www.burkert.com